



A single pergola set can be installed in a short period as 60 minutes



The only Limit is your imagination. You can create your own pergolas with our bracket sets

in every way



**“SUNFLEX QUALITY;
IS NEVER A COINCIDENCE,,**

SUNFLEX QUALITY;

It is the result of always setting a superior goal,
making a sincere effort and following a wise path
It is the smart choice among many alternatives

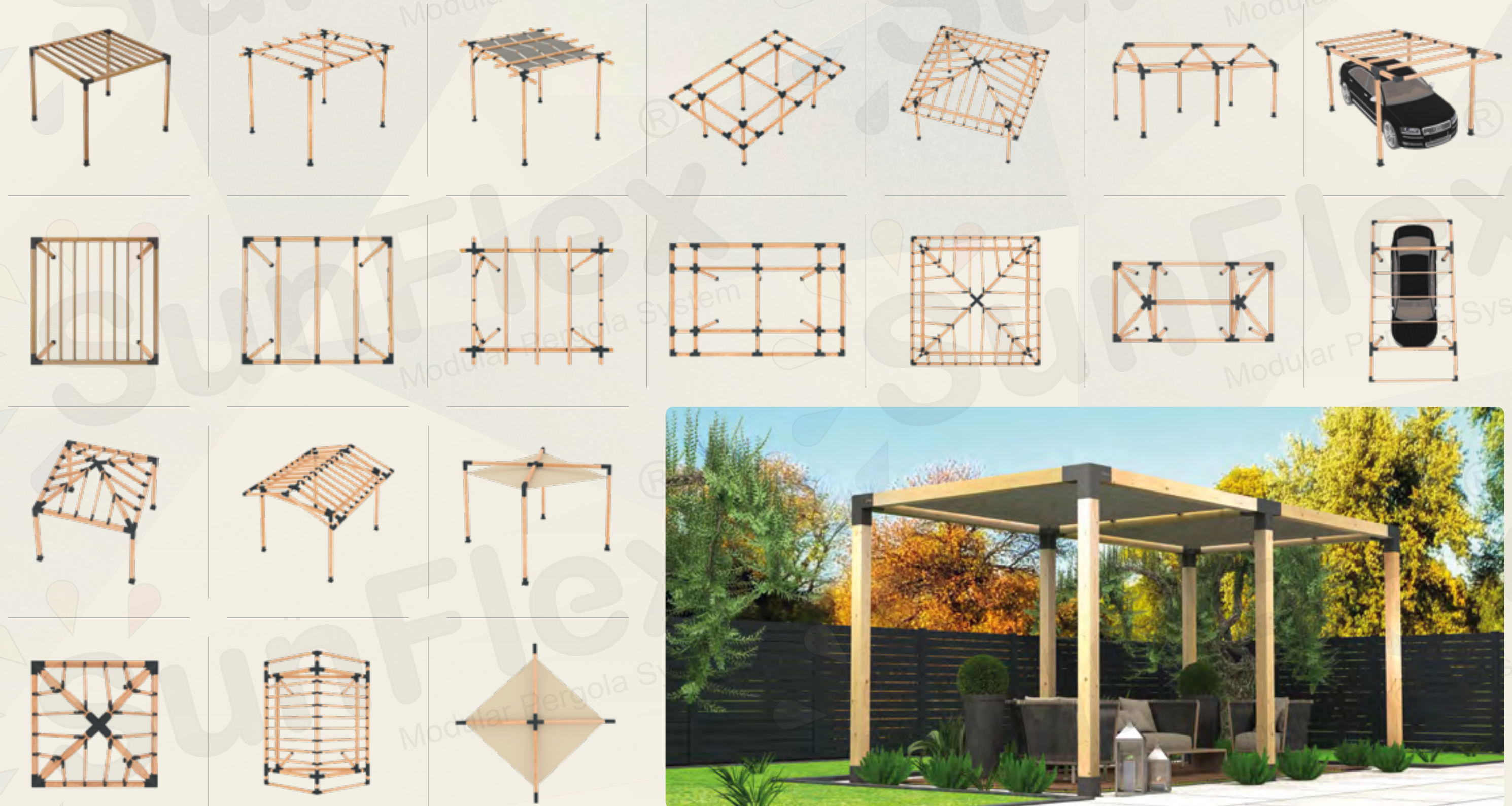

WHY SUNFLEX

Easy, Fast, Economical

It is a high quality ready-made pergola and bracket system that can be assembled easily and smoothly in a short period and use for a long time without any problems.

Durable

Sunflex brackets system provides you to have a modular pergola that will stay neat over time by grasping the wood tightly from all 4 edges without notching or cutting if beams are in right size. It maintains its durability against wind and impacts for years without any problems. It is time labor-cost saving.

10 Years Warranty

Sunflex brackets are coated with cathophoresis coating and clas 2 polyester powder paint after cutting and welding cleaning. Thanks to these processes that guarantees trouble-free use for 10 years, including at the seaside.

Assemble, Disassemble, Re-assemble

Sunflex pergola system allows you to apply in many different ways. You can disassemble Sunflex products and take them to another place, and enlarge or reduce the size as you wish.

From Sun or Rain

After installation, you can cover the top of Sunflex products with a sunshade, a retractable awning, a top-down awning, a detachable roof awning or a fixed awning.

Dense wood beams also can be another option to provide protection from the sun.

You can buy only Sunflex brackets, purchase wooden beams locally and assemble easily.

Also Sunflex sets including beams and sunshade can be purchased as a package.

SUNFLEX DURABLE MATERIAL AND QUALITY WORKMANSHIP

 <p>MODULAR</p> <p>Sunflex's modularity allows you to change the entire system and add or remove sections</p>	 <p>FAST INSTALLATION</p> <p>You can create a new living space by applying our pergola sets in a short period as 60 minutes per section</p>	 <p>ROBUST AND DURABLE</p> <p>Sunflex brackets are produced with High quality steel coated cathophoresis and electrostatic powder painting</p>
 <p>RESIDENCES</p> <p>Sunflex can be assembled in many ways and thanks to its modularity, you can use it in your garden or on your veranda</p>	 <p>WORKPLACE</p> <p>You can create useful areas in front of workplaces in all seasons</p>	 <p>HOTEL AND HOLIDAY VILLAGES</p> <p>It will be your choice in hotels, cafes, beaches, holiday villages and restaurants with its easy, flexible and decorative beauty suitable for all sizes</p>

* Ask from your dealer.

* With your family or friends assemble it with fun. Or request assembly.



READY WOODEN PERGOLA SETS

CONTENTS

 <p>Classic 9x9 - 14x14 PAGE 6 - 12</p>	 <p>Exotic Ø 8,2 PAGE 18</p>	 <p>Roof 7 Roofed 9x9 - 14x14 PAGE 22</p>
 <p>Roof 20 with Roof and Eaves 9x9 - 14x14 PAGE 28</p>	 <p>Roof 30 with Roof 9x9 - 14x14 PAGE 32</p>	
<p>Sunshade PAGE 36</p> 	<p>Rain Cover PAGE 37</p> 	
<p>Wooden PAGE 38</p> 	<p>Packaging PAGE 39</p> 	



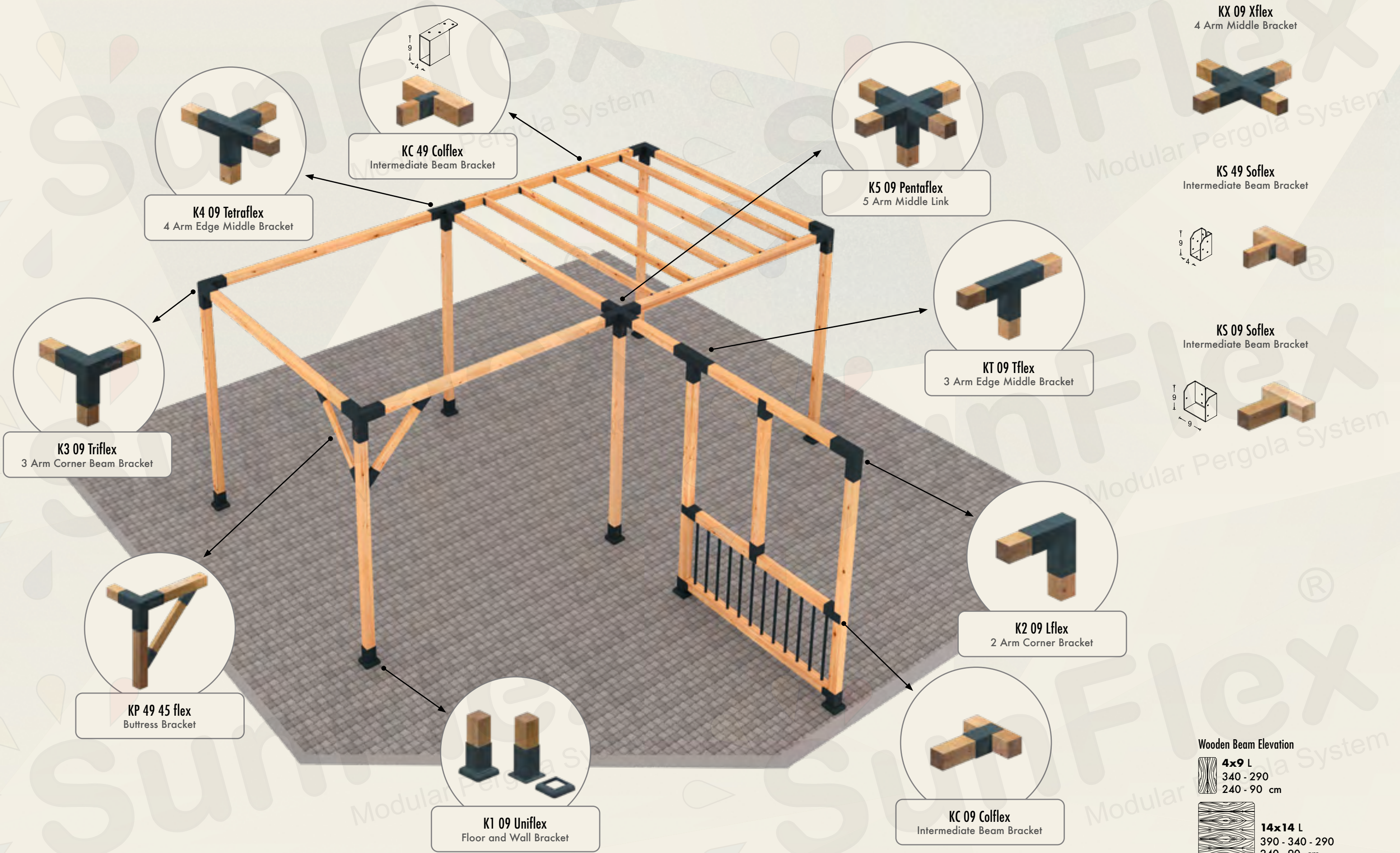



9x9 TRIFLEX

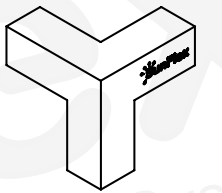
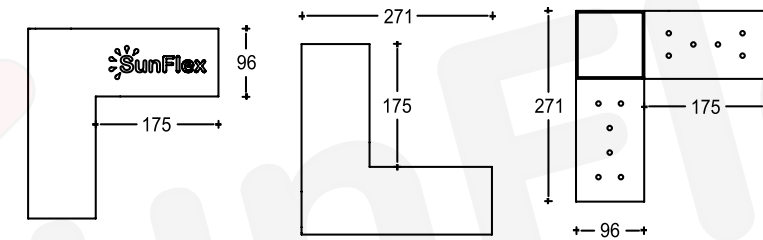

14x14 TRIFLEX

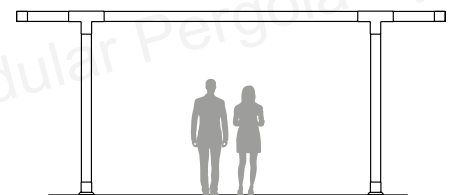
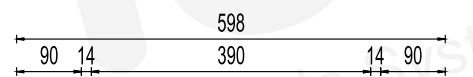
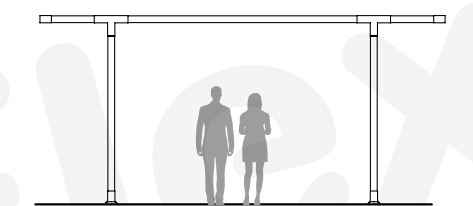
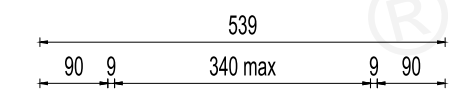
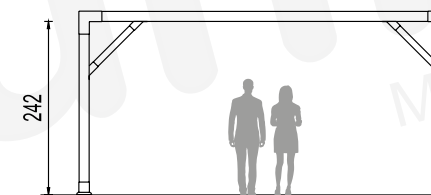
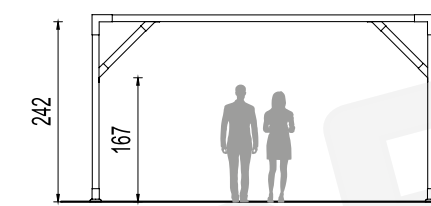
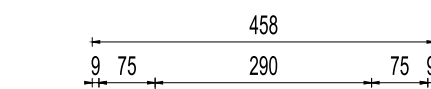
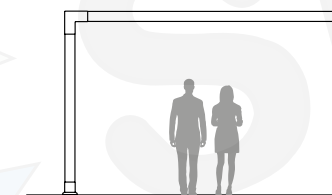
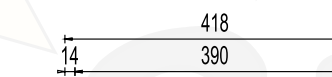
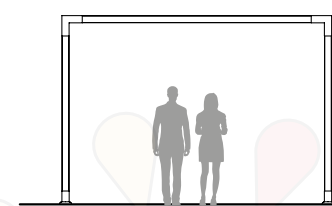
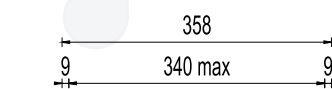
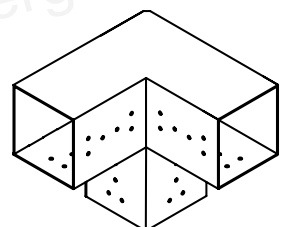
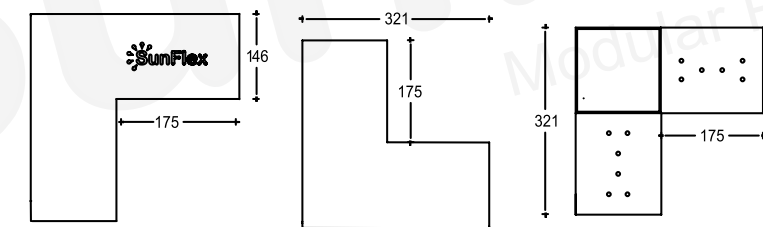



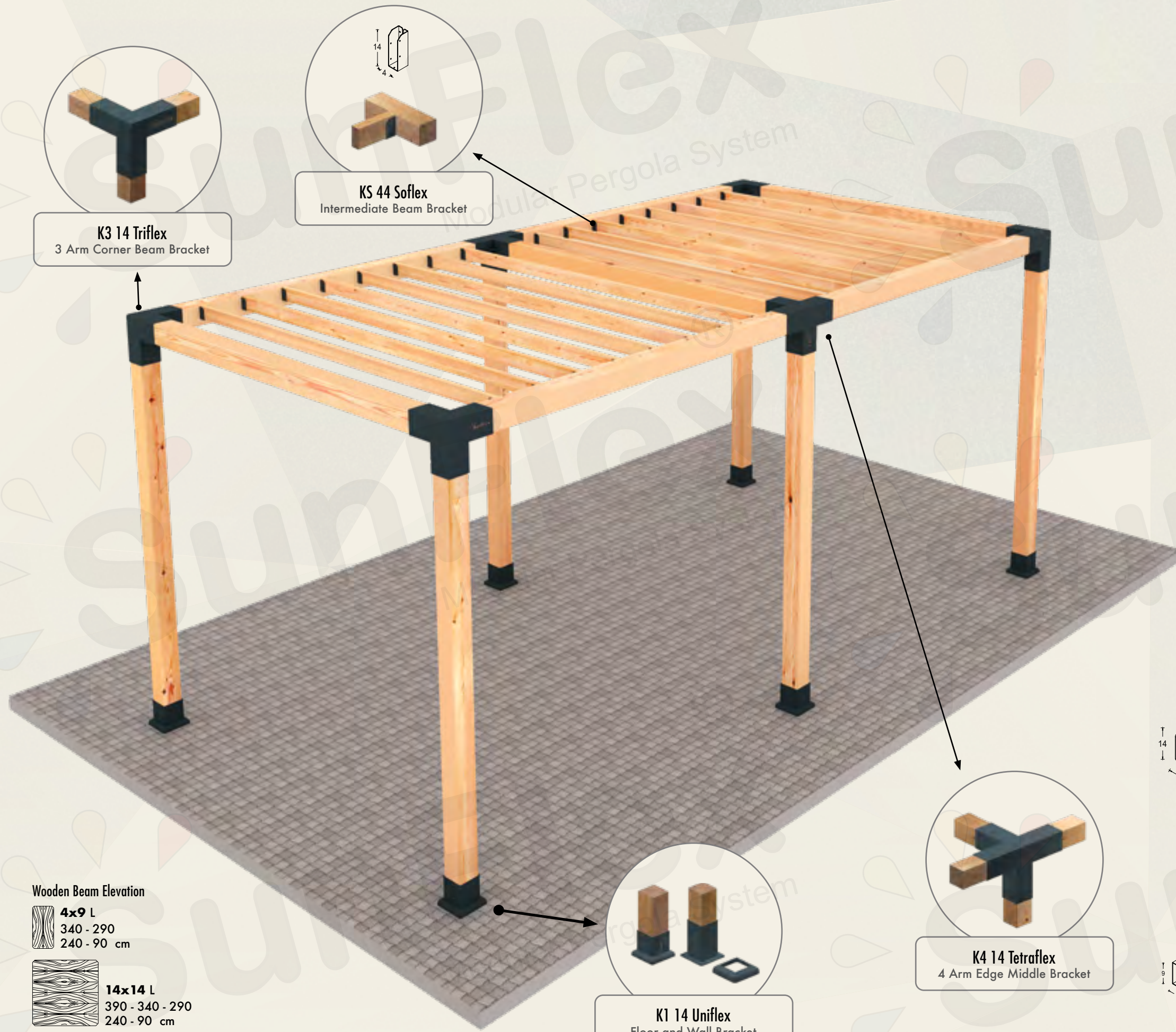

K3 14 Triflex
3 Arm Corner Beam Bracket

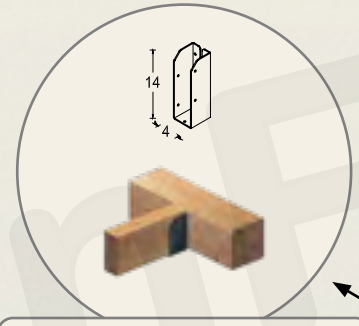

KS 44 Soflex
Intermediate Beam Bracket



K1 14 Uniflex
Floor and Wall Bracket



K4 14 Tetraflex
4 Arm Edge Middle Bracket

K2 14 Lflex
2 Arm Corner Bracket



KT 14 Tflex
3 Arm Edge Middle Bracket



K5 14 Pentaflex
5 Arm Middle Link



KX 14 Xflex
4 Arm Middle Bracket



KC 14 Colflex
Intermediate Beam Bracket

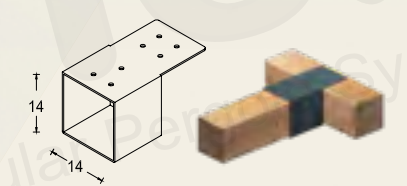

KS 14 Soflex
Intermediate Beam Bracket

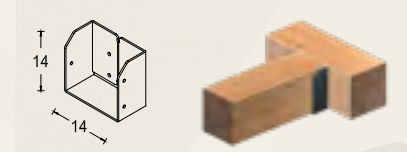

KC 44 Colflex
Intermediate Beam Bracket



KP 09 45 flex
Buttress Bracket

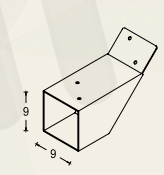

KP 49 45 flex
Buttress Bracket

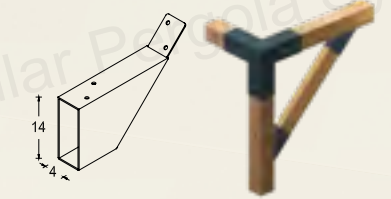

Wooden Beam Elevation

4x9 L
340 - 290
240 - 90 cm

14x14 L
390 - 340 - 290
240 - 90 cm





E4 82 Tetraflex
3 Arm Corner Beam Top Bracket



EC 82 F Colflex
Intermediate Beam Middle Bracket



E5 82 Pentaflex
5 Arm Middle Link



E0 82 0 Colflex On
Awning Connection Set



E3 82 Tflex
3 Arm Edge Middle Bracket



EP 82 45 flex
Buttress Bracket

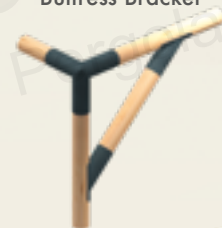

E5 82 0 Pentaflex On
5 Arm Middle Link



EP 82 45 0 flex
Buttress Bracket

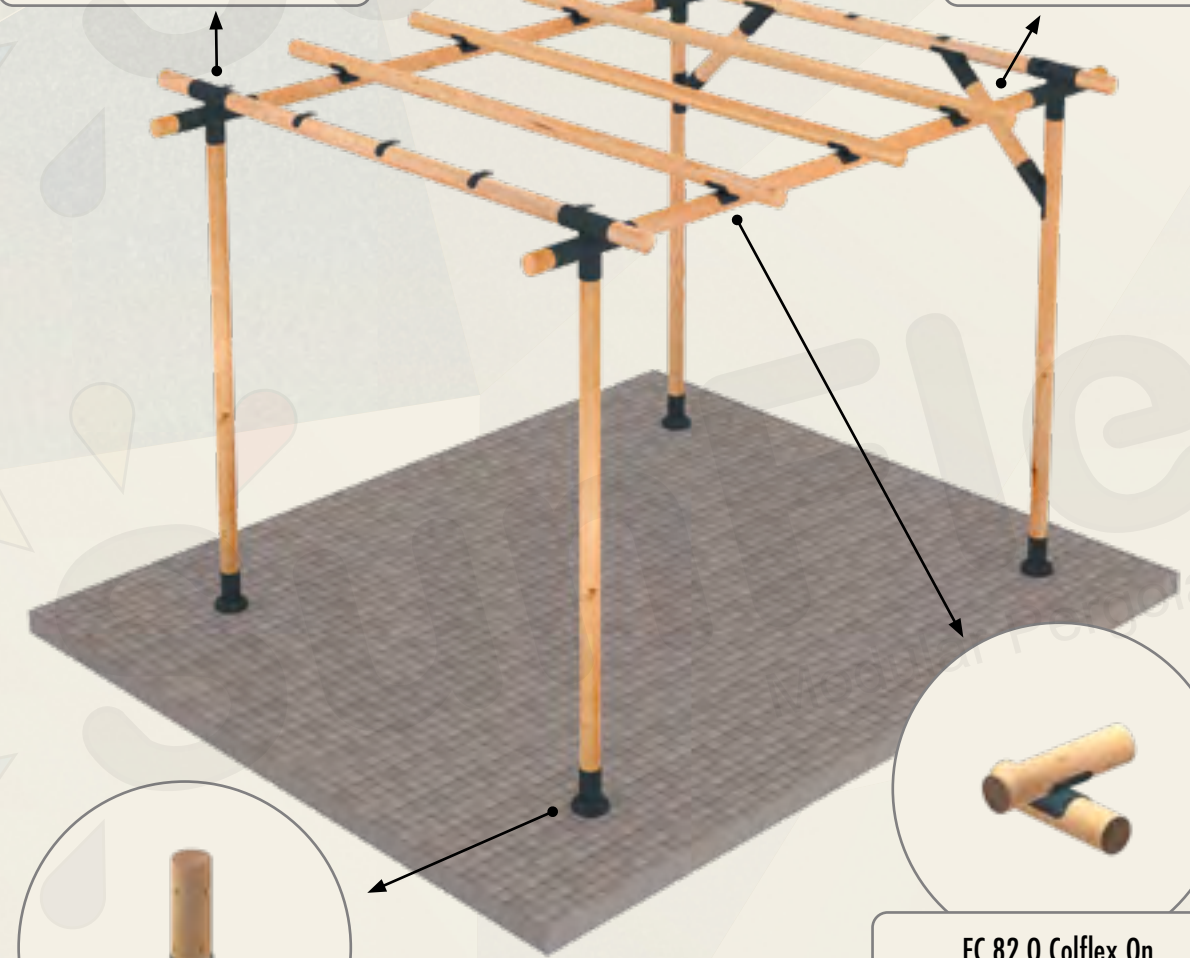

E1 82 0 Uniflex
Floor and Wall Bracket



EC 82 0 Colflex On
3 Arm Edge Middle Bracket

Wooden Beam Elevation
 Ø 8,2 L
 340 - 290
 240 - 90 cm

E0 82 0 Colflex On
Awning Bracket Set



E4 82 0 Tetraflex On
4-Arm Middle Link



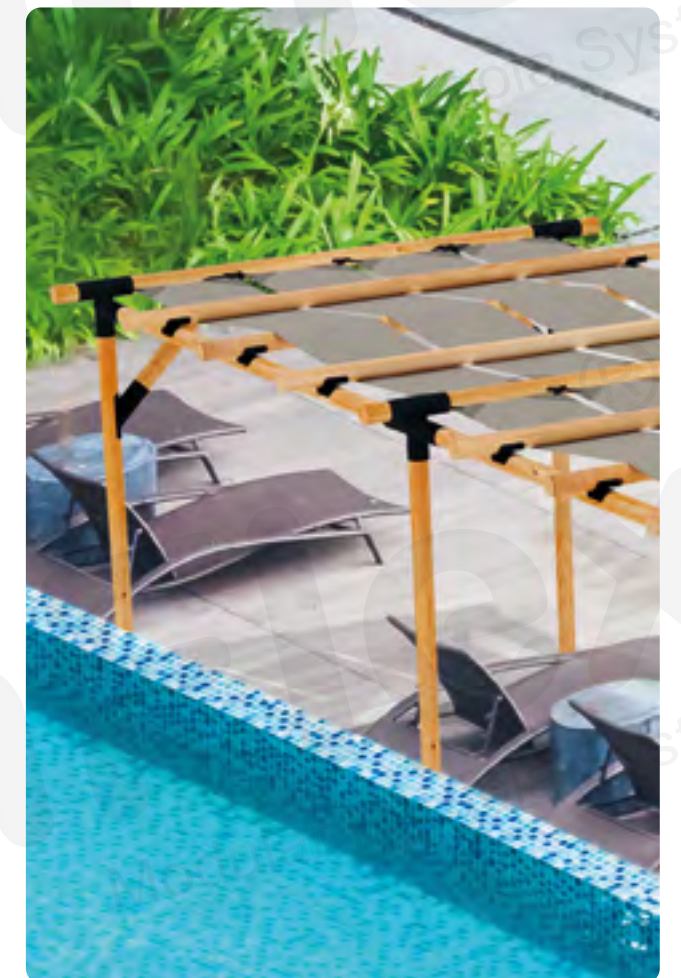
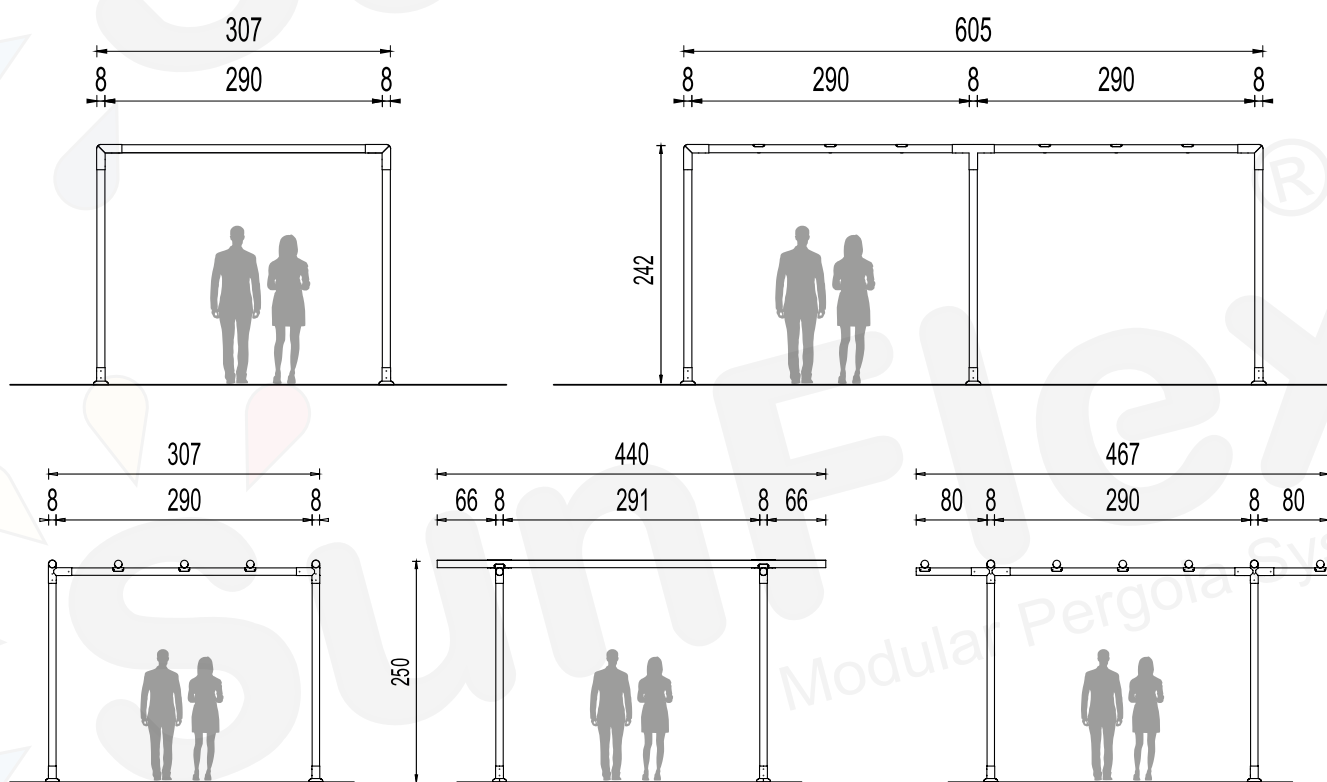



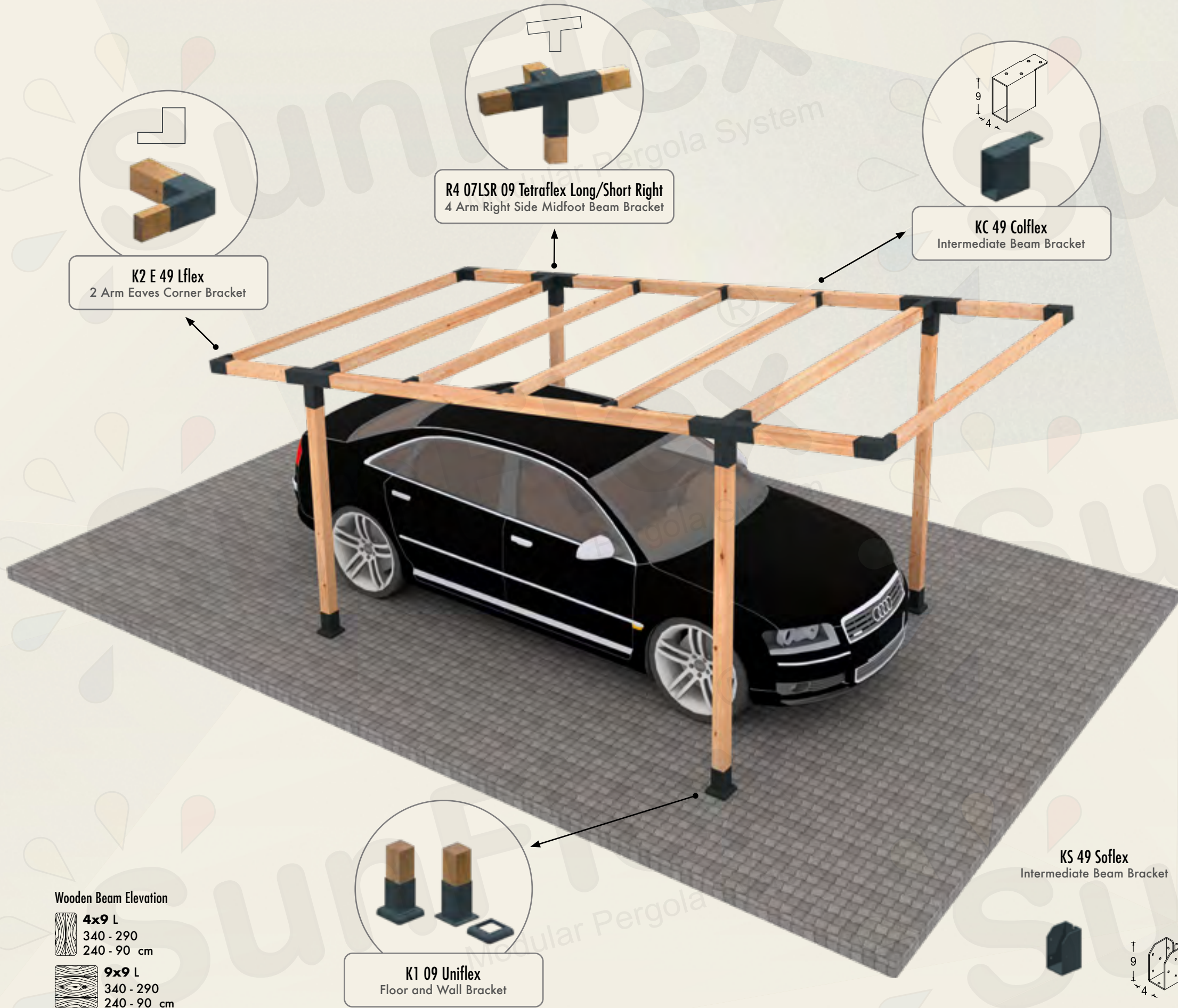

Wooden Beam Elevation

4x9 L
340 - 290
240 - 90 cm

9x9 L
340 - 290
240 - 90 cm



K1 09 Uniflex
Floor and Wall Bracket

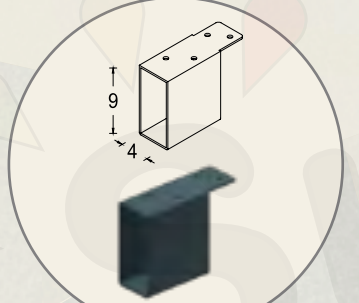

KC 49 Colflex
Intermediate Beam Bracket

R3 07SL 09 Triflex
3 Arm Short Right Leg Beam Bracket



R3 07SR 09 Triflex Right Short
3 Arm Short Right Foot Beam Bracket

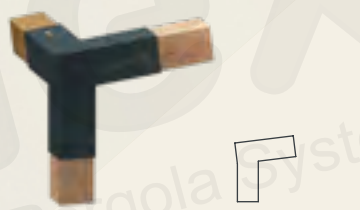

R3 07LL 09 Triflex
3 Arm Long Left Foot Beam Bracket



R3 07LR 09 Triflex Right Long
3 Arm Long Left Leg Beam Bracket



R4 07LO 09 Tetraflex Long Medium
4 Arm Long Side Mid Foot Beam Bracket



R4 07SO 09 Tetraflex Short Medium
4 Arm Short Side Mid Foot Beam Bracket



R4 07LSL 09 Tetraflex Left
4 Arm Left Side Beam Bracket



R5 07LSO 09 Pentaflex Middle
5 Arm Mid-Foot Beam Bracket



R1 07 09 Uniflex
Wall Mount



KT E 49 Tflex
3 Sleeve Eaves Middle Bracket

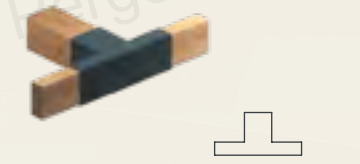

KS 49 Soflex
Intermediate Beam Bracket

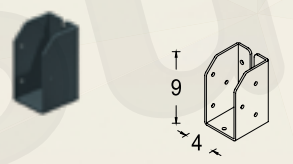

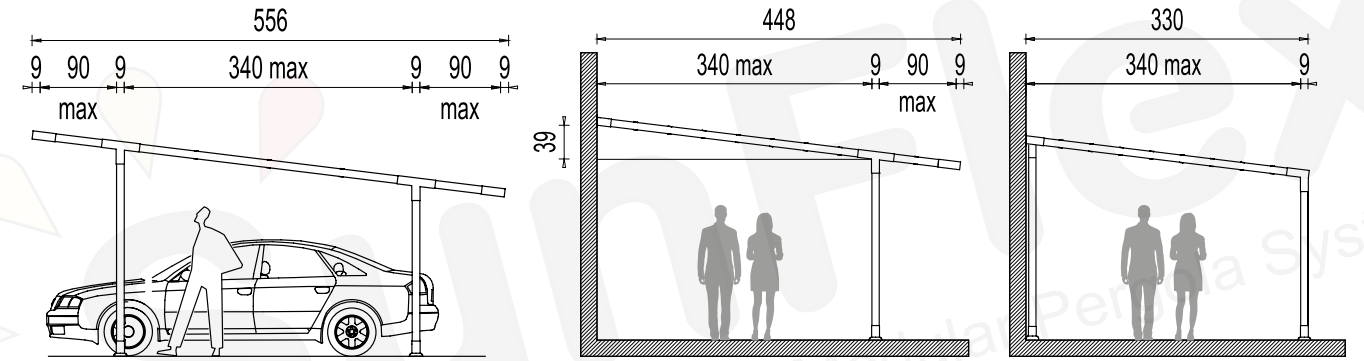
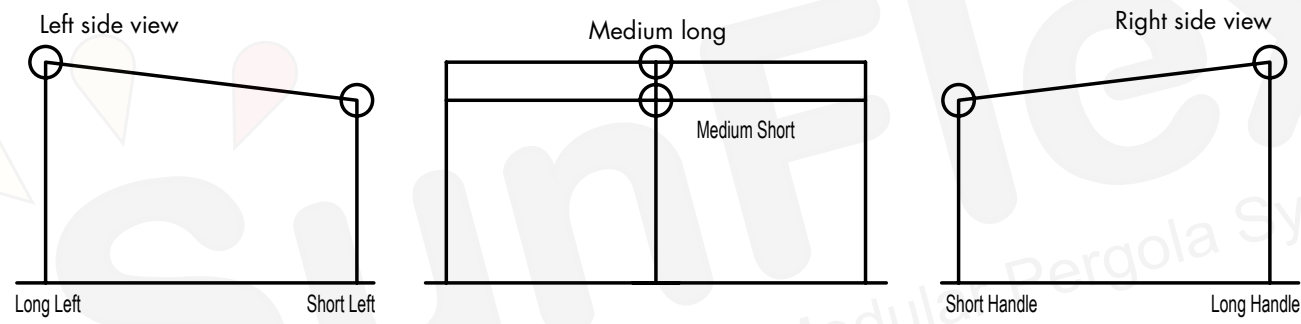

Protect your vehicle from sun and rain. Take advantage of the sun with solar panels on the roof. It is also suitable if you want to use a garage or independent 7° pergola as a canopy, rain cover, awning or paneling. Can be used for 9x9 wood sections.



Wooden Beam Elevation

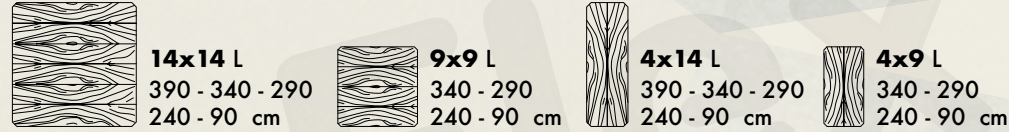

R5 2045M 09 Pentaflex
R5 2045M 14 Pentaflex
5 Arm Roof Front Ridge



RC 20M 49 Roof Colflex
RC 20M 44 Roof Colflex
Intermediate Beam
Ridge Bracket



R4 20M 09 Roof Tetraflex
R4 20M 14 Roof TetraFlex
4 Arm Roof Middle Ridge



R4 2045F 09 Roof Tetraflex
R4 2045F 14 Roof Tetraflex
4 Arm Roof Open Ended Corner



R3 2045E 49 Roof Triflex
R3 2045E 44 Roof Triflex
3 Arm Ridge Eaves
Corner Bracket

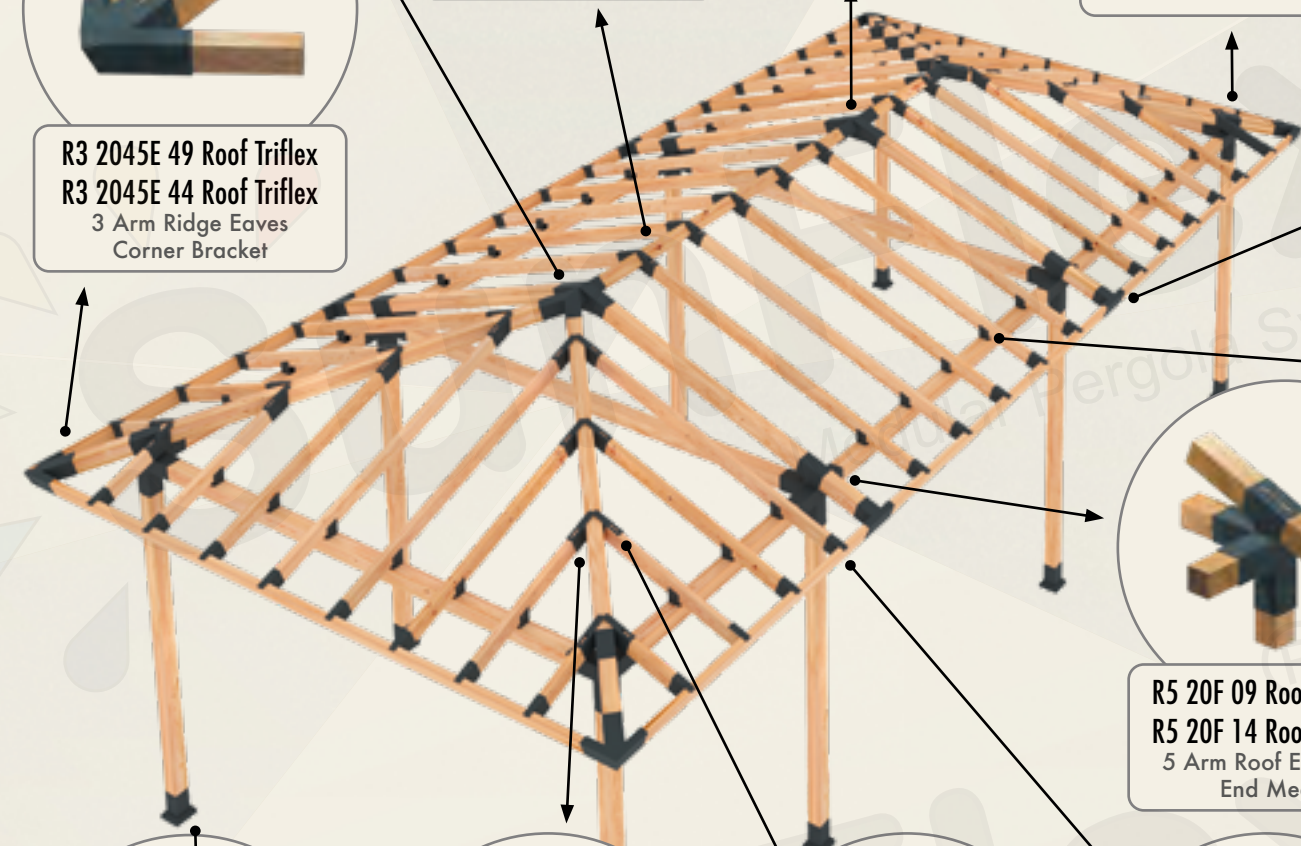

R5 20F 09 Roof PentaFlex
R5 20F 14 Roof PentaFlex
5 Arm Roof Edge Open
End Medium

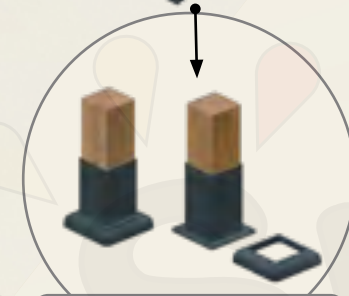

K1 09 Uniflex
K1 14 Uniflex
Floor and Wall Bracket



RC 2045MR 49 Roof Colflex
RC 2045MR 44 Roof Colflex
Intermediate Beam Ridge
Right Bracket



RC 2045ML 49 Roof Colflex
RC 2045ML 44 Roof Colflex
Intermediate Beam Ridge
Left Bracket

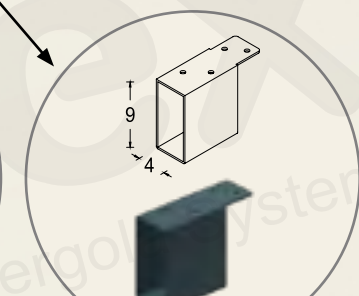

KC 49 Colflex
Intermediate Beam
Bracket

R1 20 09 Roof Uniflex
R1 20 14 Roof Uniflex
Wall Mount



KT E 99 Lflex
3 Sleeve Eaves Middle
Bracket



K2 E 99 Lflex
K2 E 11 Lflex
2 Arm Eaves Corner
Bracket



R3 2045M 09 Triflex
R3 2045M 14 Triflex
3 Arm Roof Front Ridge



R3 20M 09 Roof Triflex
R3 20M 14 Roof Triflex
3 Arm Roof Front Ridge

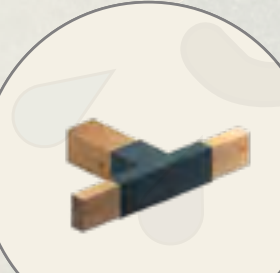

KT E 49 Tflex
3 Sleeve Eaves Middle
Bracket



RS 20 49 Roof Soflex
RS 20 44 Roof Soflex
Intermediate Beam
Bracket

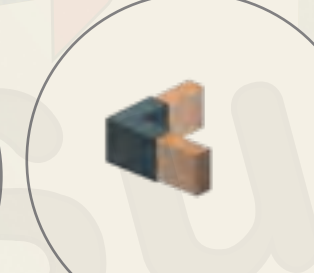

K2 E 99 Lflex
K2 E 11 Lflex
2 Arm Eaves Corner
Bracket



RX 2045M 09 Roof Xflex
RX 2045M 14 Roof Xflex
4 Arm Roof Central
Central Ridge



R4 20LF 09 Roof Tetraflex
R4 20LF 14 Roof Tetraflex
4 Live Roof Open End
Left Corner

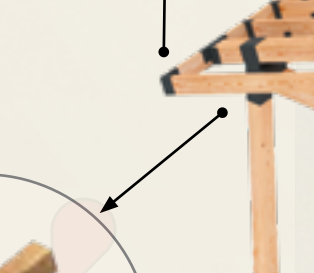

R3 20M 49 Roof Triflex
R3 20M 44 Roof Triflex
3 Arm Roof Front Ridge
Eaves Bracket



R4 20RF 09 Roof Tetraflex
R4 20RF 14 Roof Tetraflex
4 Arm Roof Open End
Right Corner

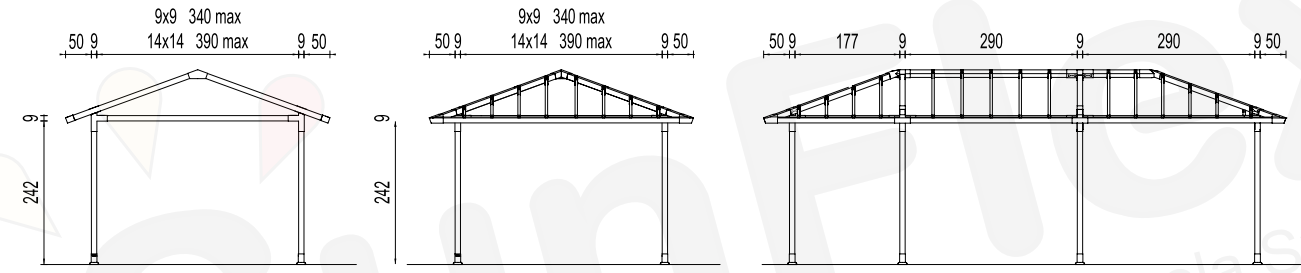

Wooden Beam Elevation

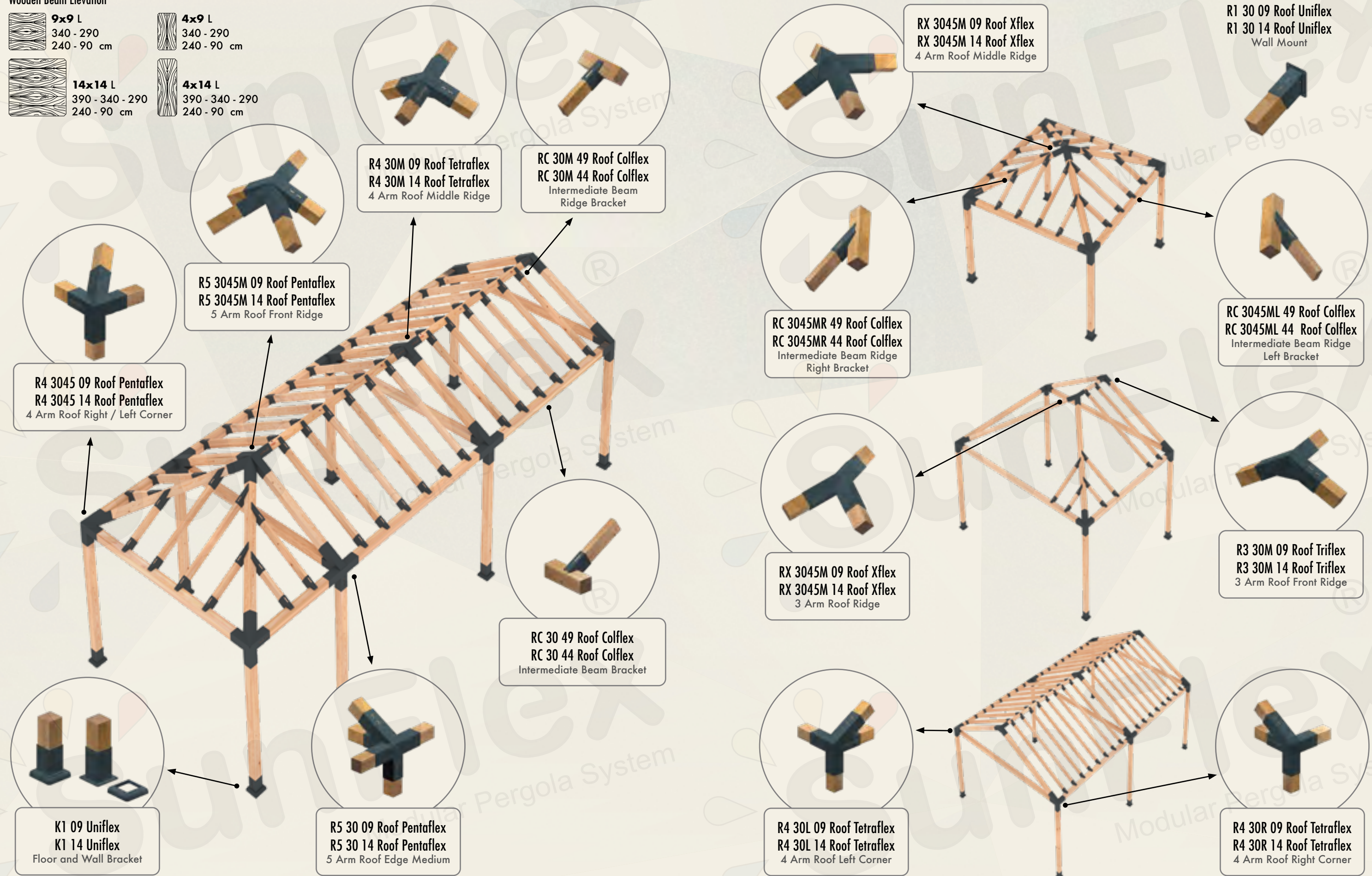

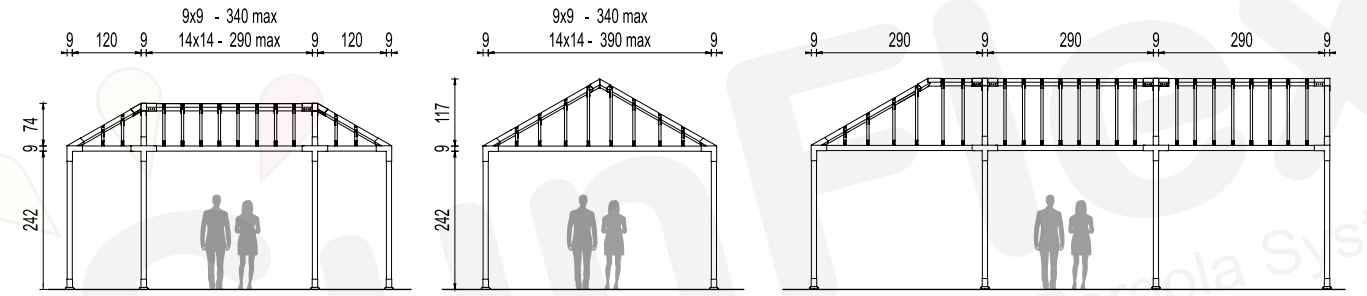
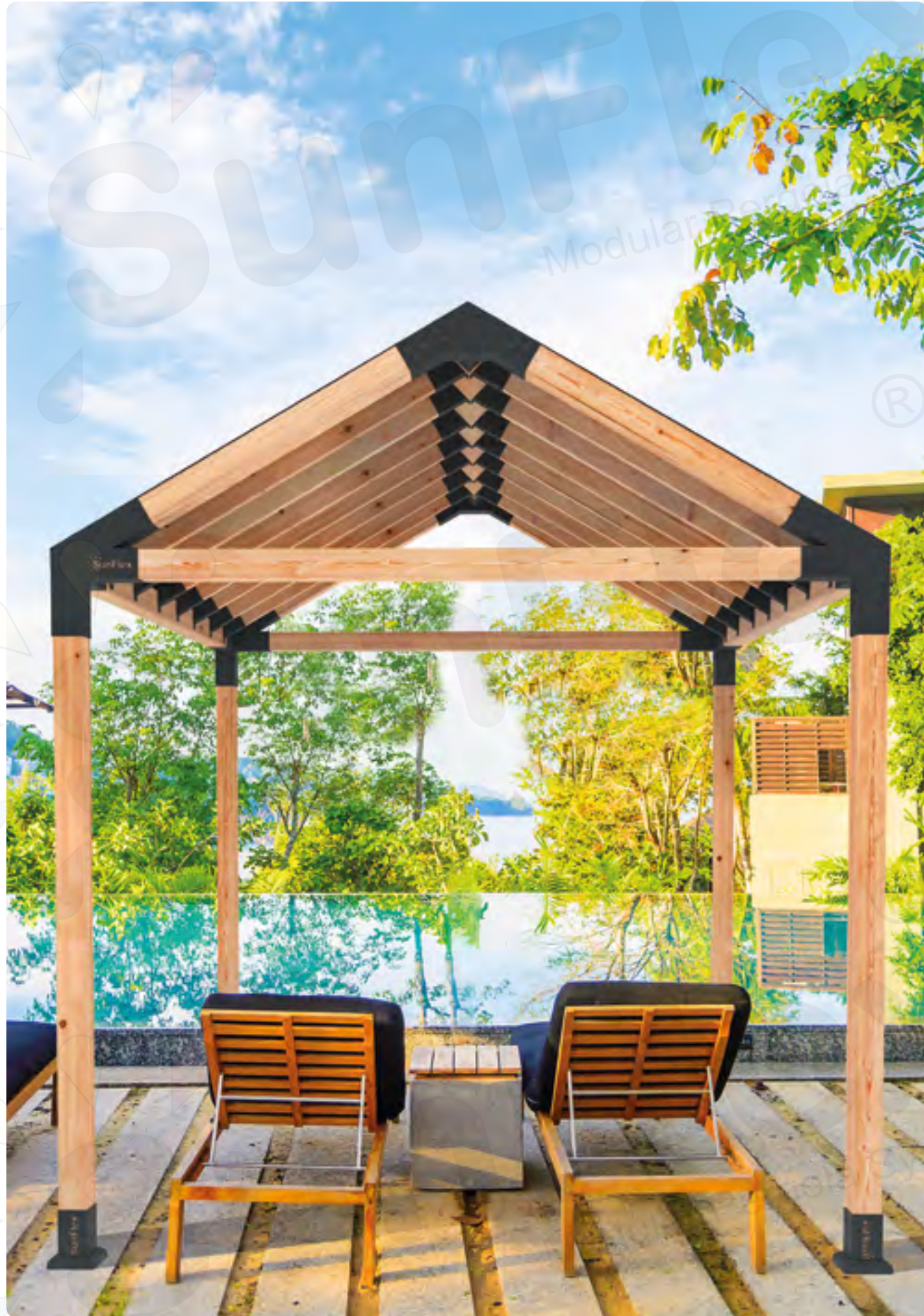

SUNSHADE

SOLO



- Sunflex Sunshades are made of UV resistant polypropylene material with high density and strength.
- Sunflex Sunshades are strong and long-lasting, protecting you from 90% of UVA and UVB.
- Sunflex Sunshades are harmless to health. It is resistant to high temperature and humidity conditions.
- Please note that do not leave Sunflex Sunshades exposed in winds exceeding 50 km/h to avoid damage and contamination.



RAIN COVER

in every way

DIFFERENT OPTIONS OF SUNSHADE AND RAIN COVER AVAILABLE

TWICE

Open Close

TWICE Open Close retractable awning; When you want to use the top of your pergola open or closed depending on weather conditions...



RAKS

From Bottom to Top

With RAKS awning, you can reduce the sun's light and protect yourself from light rain by using either a canopy or raincoat fabric. It can be made in one piece or multiple pieces.



SIGMA

Plug In

SIGMA provides safer use while being protected from sun and rain.

However, it allows you to remove your awning when necessary.



FIXED

Still



FLOW

Butterfly

FLOW awning is a new and aesthetic model for those looking for a change. It provides ease of assembly and disassembly by connecting from 4 corners.

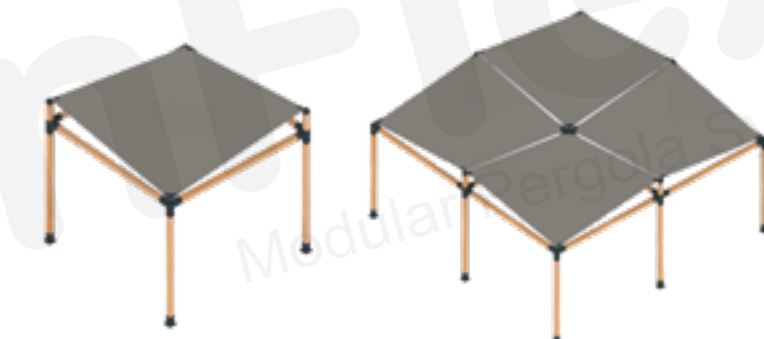

LAMINATED WOODEN BEAM SECTIONS

1st Class Pine and Iroko

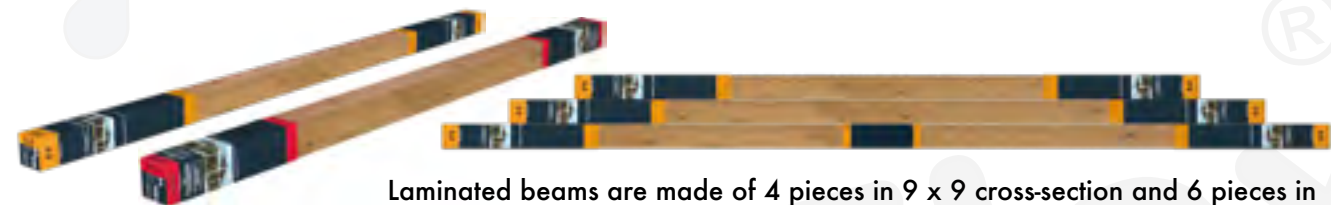
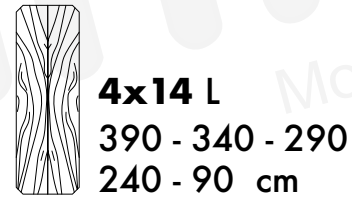
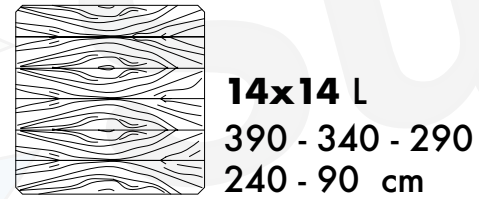
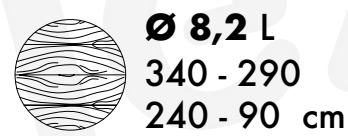
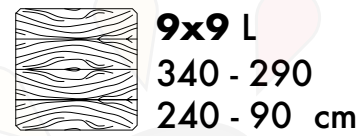

Laminated beams are made of 4 pieces in 9 x 9 cross-section and 6 pieces in 14 x 14 cross-section, pressed with D4 glue to increase their quality and strength.

FEEL YOURSELF IN NATURE

- Wood is healthy, gives you happiness and relieves your stress.
- It is a natural, organic, human-friendly and warm material.
- It has a wide variety of colors, patterns, textures and sizes. It has superior aesthetic and acoustic properties. Compared to other building materials, it is the building material that is most easily sourced and can be renewed most quickly.
- Wood is strong and has a high bearing capacity.
- It can carry more load than steel.
- It is a much more economical option.

SUNFLEX;

In order to respond to different color options on wooden beams, the upper surface color and varnish process is left to the user.

Wooden beams should be coated with water/oil based wood paints, colorless varnish or colored paint. You can protect it with varnishes.



BEAMS COLOURS

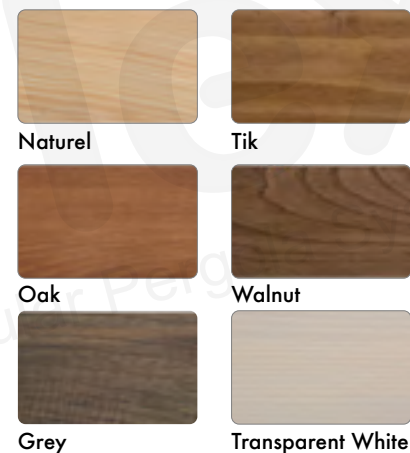

SUNFLEX PERGOLA SYSTEM SIZE TABLE

Section	Outside Outside	Sneakingly	From axis Pergola Dimension	Tree Boy Size	Canopy Stitched Outside to Outside
9 x 9	260 x 260	240 x 240	250 x 250	240 x 240	230 x 230
9 x 9	310 x 310	240 x 290	250 x 300	240 x 290	230 x 280
9 x 9	260 x 310	240 x 340	250 x 350	240 x 340	230 x 330
9 x 9	310 x 310	290 x 290	300 x 300	290 x 290	280 x 280
9 x 9	310 x 360	240 x 340	300 x 350	240 x 340	280 x 330
9 x 9	360 x 360	340 x 340	350 x 350	340 x 340	330 x 330
<hr/>					
14 x 14	270 x 270	240 x 240	255 x 255	240 x 240	230 x 230
14 x 14	320 x 320	240 x 290	355 x 305	240 x 290	230 x 280
14 x 14	270 x 320	240 x 340	255 x 355	240 x 340	230 x 330
14 x 14	270 x 420	240 x 390	255 x 405	240 x 390	230 x 380
14 x 14	320 x 320	290 x 290	305 x 305	290 x 290	280 x 280
14 x 14	320 x 370	290 x 340	305 x 355	290 x 340	280 x 330
14 x 14	320 x 420	290 x 390	305 x 405	290 x 390	280 x 380
14 x 14	370 x 370	340 x 340	355 x 355	340 x 340	330 x 330
14 x 14	370 x 420	340 x 390	355 x 405	340 x 390	330 x 380
14 x 14	420 x 420	390 x 390	405 x 405	390 x 390	380 x 380

HIGH AND SUSTAINABLE QUALITY



PACKAGING



VEGA YAPISAL
Ürünler San. ve Tic. A.Ş.

**VEGA STRUCTURAL PRODUCTS INDUSTRY
AND TRADE ANONYMOUS COMPANY**

HEAD OFFICE - ISTANBUL

P: +90 212 289 00 11

Leylak Str. Murat Business Center B F:12 A:40
Mecidiyeköy - ŞİŞLİ

FACTORY - ISTANBUL

P: +90 212 731 20 57

6093 Str. 750 Island 1 Parcel No: 10
Selimpaşa - SİLİVRİ

AEGEAN REGIONAL DIRECTORATE - IZMIR

P: +90 232 264 61 50 - P:+90 533 482 83 05

Yeşillik Str. Selgeçen Business Center No: 230
F: 4 - 422 Karabağlar - İZMİR

CENTRAL ANATOLIA REGIONAL DIRECTORATE - ANKARA

P: +90 312 353 75 20 - P: +90 533 601 99 48

Ata District Kabil Str. (4. Str.) No: 108/16 Öveçler - Çankaya

MEDITERRANEAN REGIONAL DIRECTORATE - ANTALYA

P: +90 533 482 83 05 - P: +90 533 482 83 08

Muratpaşa - Antalya

**EASTERN AND SOUTH EASTERN ANATOLIA
REGIONAL DIRECTORATE - GAZIANTEP**

P: +90 342 371 54 44 - P: +90 533 963 90 41

Gazi District Zübeyde Hanım Avenue 7 No Str.
Sedef Apt. No: 12/B Şehitkamil

For offers and information:

teklif@idealkabin.com.tr

